

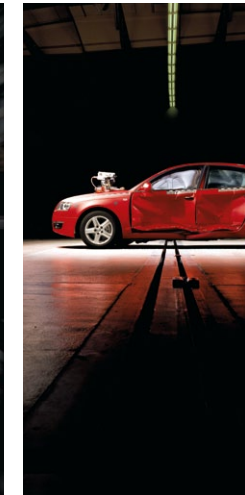

A3

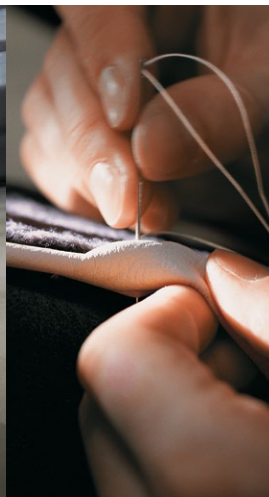

substance always wins the day



It takes more than hard work, dedication and vision to create the truly exceptional. It takes something intangible. Something you can't quite put your hands on. It's courage, guts, perseverance, passion and fierceness of focus all wrapped into one.

And it's this intangible characteristic that defines all of us at Audi. It's the driving force behind

every pencil line we draw, every calculation we make and every idea we deem not good enough.

It's why every inch and curve and angle has purpose. It's why we test our cars at the highest of speeds for hours on end so they can be driven on any surface and in any condition - rain, shine or white-out blizzard.

It's why substance always wins the day. It's why cutting a corner, even a weld seam in the trunk, would be sacrilegious. And it's why for us scrutiny is so deeply ingrained it's like the very act of breathing.

This is Truth in Engineering. And this is Audi.





A3 Premium Plus

a badge doesn't define you
it represents you



Contents

-
- ▶ 6-7 The A3 Experience
-
- ▶ 12-17 The A3 TDI® Experience
-
- ▶ 18 Performance
 - ▶ 20 TDI clean diesel
 - ▶ 22 quattro®
 - ▶ 24 S tronic®
 - ▶ 26 Safety
-
- ▶ 28 A3 Premium | Premium Plus
 - ▶ 32 A3 Options | Packages
 - ▶ 36 A3 Accessories | Wheels
 - ▶ 40 Interior Colors
 - ▶ 42 Exterior Colors
 - ▶ 45 Specifications | Configurations
-



A3



A3 Premium Plus

muscular

Designed to deliver a combination of exhilarating performance, remarkable efficiency and convenient utility in a way no other car in its class can, the A3 epitomizes progressive design, perfectly suited for city driving and winding country roads.

From any angle, the Audi A3 appears strong and athletic. Its low, wide stance declares it's ready for any curve. Short overhangs, muscular fenders and distinctive lines create a powerful look that signals it's part of a family of cars in which performance is paramount.

A number of dramatic elements make it a stylish standout. Available brilliant LED daytime running lights accent the signature Singleframe® grille, while the standard S line® fascia with foglights further enhance the purposeful look.

At the rear, form and function work seamlessly. The exhaust tips and surrounding rear diffuser create a sporty look, while the large rear hatch makes loading and unloading virtually effortless.

More than capable in every respect, the agile A3 will get you in and out of tight corners and spaces quickly and confidently.

versatility



Every aspect of the A3 blends sophisticated refinement with versatile utility. The luxurious interior is spacious enough to accommodate large-capacity loads, thanks to the 60/40 split folding rear seats. Meanwhile, leather seating surfaces reflect a sense of luxury.

A distinctive, sporty elegance graces the car. The vents, light switches and center console offer a bold, contemporary look with Flexmetallic trim. The specially designed instruments feature black gauges with red needles for accurate readings, while the driver information system displays real-time MPG, outdoor temperature and navigation direction.

The interior is further enhanced with the dual-zone climate control system, ensuring you're comfortable at all times. A host of available

upgrade options include the convenience of hands-free Bluetooth® technology as well as the superior BOSE® audio system.

- 1 The available Open Sky panorama sunroof allows plenty of fresh air and sunlight in to create a refreshing and light-filled interior.
- 2 The 60/40 split folding rear seats offer the versatility of multiple configurations and a maximum cargo capacity of 39 cu. ft.
- 3 The available three-spoke, leather-wrapped, multifunction steering wheel is designed for those who appreciate the feel of fine, hand-stitched leather and also offers the convenience of accessing radio functions and your Bluetooth-enabled telephone.





A3 Premium Plus

anticipate





A3 Premium Plus

Superior performance has always been an Audi hallmark and the A3 is another classic example. Available quattro® all-wheel drive is the heart and soul of Audi handling. Delivering superlative confidence for the driver when the weather is less-than-ideal, quattro is an essential component to responsive handling.

Paired with a 2.0T 200hp engine producing 207 lb-ft. of torque, the A3 delivers impressive performance whether you're in the city or on an apex-filled mountain road.

Precise handling is also a product of the MacPherson front suspension and multi-link rear suspension, which provide a high level of lateral rigidity and inspire total confidence in any turn. There's also the advanced technology and safety of the Electronic Stabilization Program (ESP®), which helps ensure your A3



maintains the intended direction of travel by continuously and instantly adjusting a number of drivetrain variables, including the throttle, transmission and the brakes via ABS.

Servotronic® steering is another important factor of superior handling in the A3. The speed-sensitive, electromechanical power steering system allows for more precise control at higher speeds. At lower speeds, like in a parking lot, Servotronic steering decreases resistance, allowing for easier steering input.

The culmination is a car that performs extraordinarily well. The A3 is ideal for the tight confines of urban settings but provides a bold and exhilarating driving experience in any environment.

TDI



Green Car of the Year[®]



A3 TDI® Premium Plus

To be named “2010 Green Car of the Year®” by *Green Car Journal*, you have to perform flawlessly in a number of highly competitive categories. Among those are fuel efficiency, technology, performance and overall luxury. It’s no surprise, then, that the A3 TDI® came out on top on all accounts.

As the leader in clean diesel technology, Audi TDI produces 30 percent fewer CO₂ emissions than gasoline-powered engines. In other words, it is possible to be powerful, efficient, quiet and clean without sacrificing performance. The A3 TDI is proof.

* *Green Car Journal*, December, 2009. † A3 TDI EPA estimates: 30/42 city/highway MPG. Your mileage will vary.

instantaneous

Behind the trademark Singleframe® grille is the Audi 2.0 TDI® direct injection turbocharged clean diesel engine. It offers 140hp and an impressive 236 lb-ft. of torque for smooth yet responsive performance. In fact, it's the same DNA and advanced technology that propelled the R10 Le Mans Prototype racecars to a record number of victories.

Rapid acceleration, impressive efficiency* and progressive performance are engineered into every A3 2.0 TDI, making it just as at home on the track as it is in your garage.

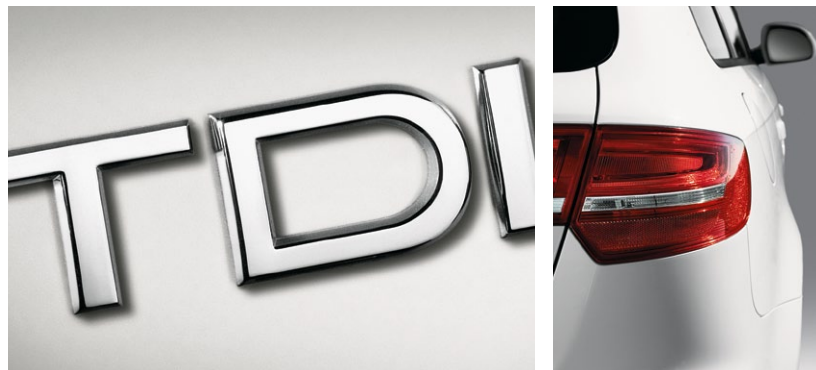



A3 TDI® Premium Plus





A3 TDI® Premium Plus

street smart

The A3 TDI® is ideally suited for urban living. It offers essential five-door utility with quick off-the-line acceleration as well as rapid-fire shifting thanks to the standard S tronic® transmission. Inside, innovative technology and a luxurious cabin create a sensory-rich driving experience. The A3 TDI delivers it all without sacrificing the performance and handling Audi is renowned for – and that the city demands.

TDI technology enables the A3 to achieve 30 MPG* in the city and a category-leading 42 MPG* on the highway while still being bullish on performance. That class-leading fuel efficiency means greater range and fewer stops at the pump. Simply put, the A3 TDI clean diesel uncompromisingly delivers both incredible power and superior fuel efficiency.

*EPA estimates. Your mileage will vary.





performance fueled by unconventional thinking

FSI®

Audi Fuel Stratified Injection, or FSI®, offers the benefits of increased performance and fuel efficiency. FSI direct injection delivers a precise amount of fuel directly into the engine cylinders, as opposed to the engine intake runners. This advanced process helps ensure a more complete combustion, thereby diminishing waste and increasing power.

Within the cylinder, the specially designed piston heads compress the fuel-air mixture in a spiraling motion, creating the most efficient combustion possible. Making the

most of these technologies allows for greater efficiency in the combustion process.

By combining FSI and forced induction, such as a turbocharger, the 2.0T engine employs a variation of FSI called TFSI®. The principle and benefits are identical. TFSI-equipped engines take advantage of significantly higher compression ratios and cylinder pressure, thus fully atomizing fuel and optimizing boost response. The compressor condenses the air flowing into the engine, allowing more air into the cylinder and therefore more power from each ignition.

pulse



2.0 liter TFSI® engine with 1984 cc of displacement

Maximum 200hp @ 5100-6000 RPM

Maximum 207 lb-ft. of torque @ 1800-5000 RPM

Specific power output of 100hp per liter of displacement

TFSI direct injection with up to 120 bar of pressure

A high compression ratio of 9.6:1

0-60 MPH in 6.7 seconds



A forced-induction engine produces greater power than a similar engine without it, significantly improving the engine's power-to-weight ratio. Consequently, Audi is able to use smaller, more efficient engines and achieve similar power and performance results typically found in larger, less fuel-efficient engines.

The beauty of FSI® and TFSI is that they work at any RPM, maximizing efficiency and generating responsive and optimal power during all driving conditions.



2.0 TDI®

With the potent combination of direct diesel injection and turbocharging, the 2.0 liter TDI® clean diesel engine delivers an impressive 236 lb-ft. of torque and produces 140hp. The power and performance is complemented with impressive EPA-estimated 30 MPG city and 42 MPG highway ratings*. Producing 30 percent fewer CO₂ emissions than a comparable gasoline engine, the 2.0 TDI clean diesel also meets or exceeds the 50 state emissions requirements.

2.0 TFSI®

Years ahead of the competition, the Audi 2.0 liter turbocharged DOHC engine combines variable valve timing, TFSI direct injection and turbocharging for more power and greater efficiency*. The 2.0 TFSI was the first engine to combine gasoline direct injection with turbocharging in large-scale production. Producing 200hp and 207 lb-ft. of torque, it has been the engine of choice for more than 1.3 million Audi drivers worldwide.

* Your mileage will vary. * EPA estimates: 22/28 city/highway MPG. Your mileage will vary.



maximize

you've never done so much with so little

For more than 20 years, Audi TDI® has been the leader in diesel technology. It's fast and efficient, offers lower CO₂ output than gasoline engines and is extremely quiet. In fact, as a testament to its benefits, vehicles powered by diesel account for 50 percent of all vehicle sales in Western Europe.

Its efficiency was proven in 2008 during the Audi Mileage Marathon. The Audi A3 TDI achieved an extraordinary 50 MPG* on a cross-country trip from New York to Los Angeles. By using the most advanced technology of Turbo Diesel Injection, or TDI, diesel is quickly gaining popularity in the United States for several good reasons.

Power

TDI clean diesel gains its incredible power from a number of progressive technologies. With 140hp and 236 lb-ft. of torque, the A3 TDI generates quick acceleration off the line.

High-pressure direct injection is also part of what gives TDI its remarkable horsepower and torque. Supported by common-rail technology that pumps fuel through the precise Piezo injectors, an exact fuel and air mixture is achieved for maximum combustion, resulting in maximum power output. For you, that means a more exhilarating driving experience.



Efficiency

The groundbreaking 2.0 liter TDI® clean diesel engine available in the A3 delivers 140hp and 236 lb-ft. of torque, yet achieves an EPA-estimated 30 MPG city and 42 MPG highway,* which is the best of any luxury car sold in America. Additionally, the Audi A3 TDI achieves 50 percent better fuel economy than a comparable gasoline engine.

That class-leading efficiency is due in part to the common-rail injection system, which generates up to 1600 bar of pressure. Combined with the innovative pressure sensors in the combustion chamber, the common-rail injection system helps to ensure a highly efficient and low-emission combustion process.

The breakthrough efficiency also comes from a significantly higher compression ratio and cylinder pressure. This means fuel is fully atomized, optimizing turbocharger boost response as well as efficiency. TDI delivers both class-leading efficiency and power, making it the ideal efficient, performance-oriented solution.



Emissions

Long gone are the days of dirty, smoking diesel engines. Audi TDI clean diesel technology is responsible for the cleanest diesel engines in the world, with 30 percent fewer CO₂ emissions than comparable gasoline engines, making it an environmentally friendly alternative to gasoline power. In fact, TDI clean diesel is compliant with California's ULEV II requirement – the world's most stringent emission standard. The result is a significant reduction in emissions that contribute to global warming.

Motorsports

For confirmation of the incredible power generated by TDI clean diesel, all one needs to do is turn to the Le Mans-winning Audi R10 racecars powered by TDI.

Audi was the first manufacturer to introduce the potent capabilities of diesel into a modern racecar. The results have been astounding. Not only were the R10 TDI cars fast, but they routinely outdistanced the competition thanks to their efficiency. Additionally, in races where longevity and durability are critical, the Audi TDI engine proved superior.

In the past decade at the 24 Hours of Le Mans, Audi has stood atop the podium eight times. Three of those victories were due in large part to the power, reliability and efficiency of TDI. You'll find this very same technology under the hood of your Audi A3 TDI clean diesel.

*Audi A3 TDI, 50.6 combined city/highway MPG. Mileage achieved during a drive from Washington, D.C. to Cleveland, OH. IMSA certified. EPA estimates: 30/42 city/highway MPG. Your mileage will vary. † Your mileage will vary.



get ready, this is where
it becomes visceral



awe

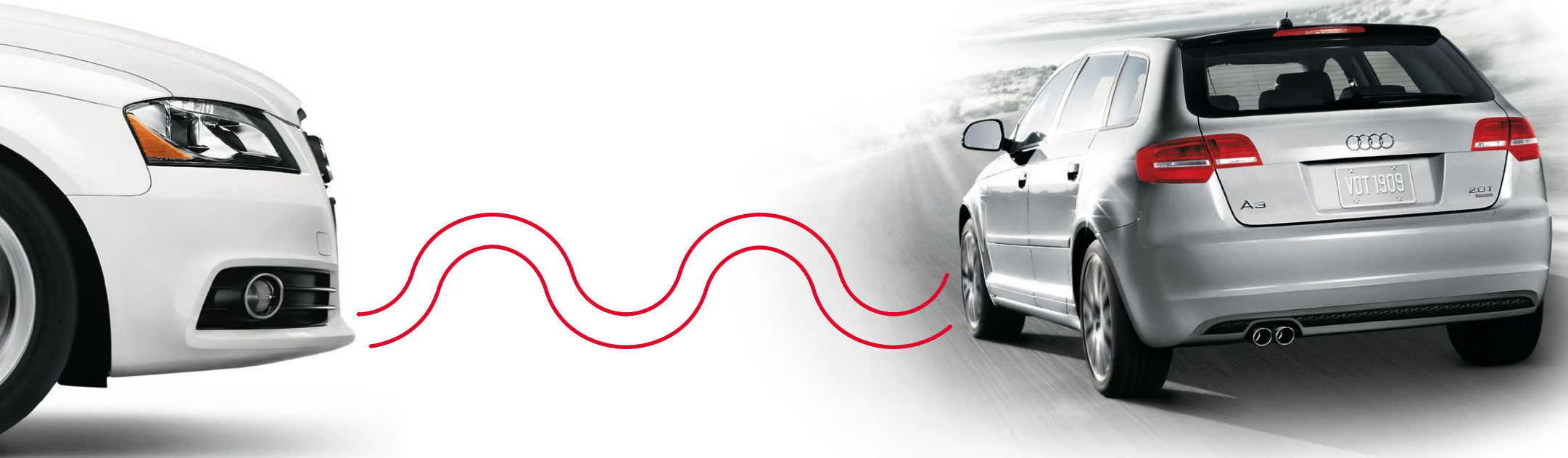

The concept is ingenious, the solution brilliant. Often imitated, nothing drives like quattro®, the world's most innovative all-wheel drive system. It's a technology that we've been developing for 30 years. And the competition? They're just now beginning to realize what we've known for three decades.

For you, quattro means unmatched traction and confidence in less-than-ideal driving conditions and unequalled performance at all other times.

Permanent all-wheel drive systems are not created equal. And they certainly don't perform that way either. quattro is essentially a dynamic hydraulic system that progressively engages depending on anticipated wheel slippage, thanks to a number of electronic controls. For instance, if a loss of traction is imminent, the system will actively manage the vehicle's available power and torque, distributing power to the front and rear wheels to provide optimal traction.

In normal driving situations, quattro distributes the power between front and rear axles by sending 85 percent to the front wheels and 15 percent to the rear wheels, enhancing the driving dynamics while maintaining optimum control. However, quattro can shift power 100 percent to the rear or front when conditions demand. Constantly assessing grip, quattro helps to ensure the best possible combination of traction and handling, regardless of the road conditions.

What you experience behind the wheel is confidence-inspiring handling. Curves are relished. Rain and snow are greeted with relative indifference. And every drive is an experience in performance bliss.



duality

one is good, two is breathtaking



The concept behind one of the world's most advanced transmissions is simple to understand and thrilling to experience: near-constant power through lightning-quick gearshifts. Utilizing two clutches, S tronic® ensures you're in the gear you select the instant you select it. There is no loss of momentum, no loss of RPM, and at a mere 0.2 seconds between shifts, no lag between gears.

Dual-Clutch

The S tronic transmission utilizes two clutches that operate independently. One clutch controls the odd gears (first, third, fifth and reverse), while the other controls the even gears (second, fourth and sixth). When the first clutch is transmitting power, the second clutch is poised to engage the next preselected gear. When you shift, the first clutch is released and the second engages; the gearshift takes place in a quick 0.2 seconds. This innovative design allows gears to be changed without interrupting the power flow from the engine to the transmission. For you, it means lightning-fast gear changes and power where you want it – at the wheels.

Dual-Mode

The S tronic transmission can be operated either automatically or manually. In automatic mode, S tronic shifts for you, so all you have to do is enjoy the rapid shifts and continuous power. In manual mode, you enjoy a more personalized driving experience by determining your own shift points. Use the center console-mounted shift lever or the shift paddles on the steering wheel to put the power in your hands.

Efficiency

The rapid-fire shifting of S tronic not only creates an exhilarating, performance-oriented driving experience, it also offers the benefit of increased fuel efficiency. Because power flow from the engine to the transmission is not interrupted, fuel efficiency increases dramatically; the velocity of the car is constant, versus having to regain lost momentum during the gear change. The result is a 10 percent increase in fuel efficiency when compared to a conventional five-speed automatic.*

* EPA estimates: 22/28 city/highway MPG. Your mileage will vary.

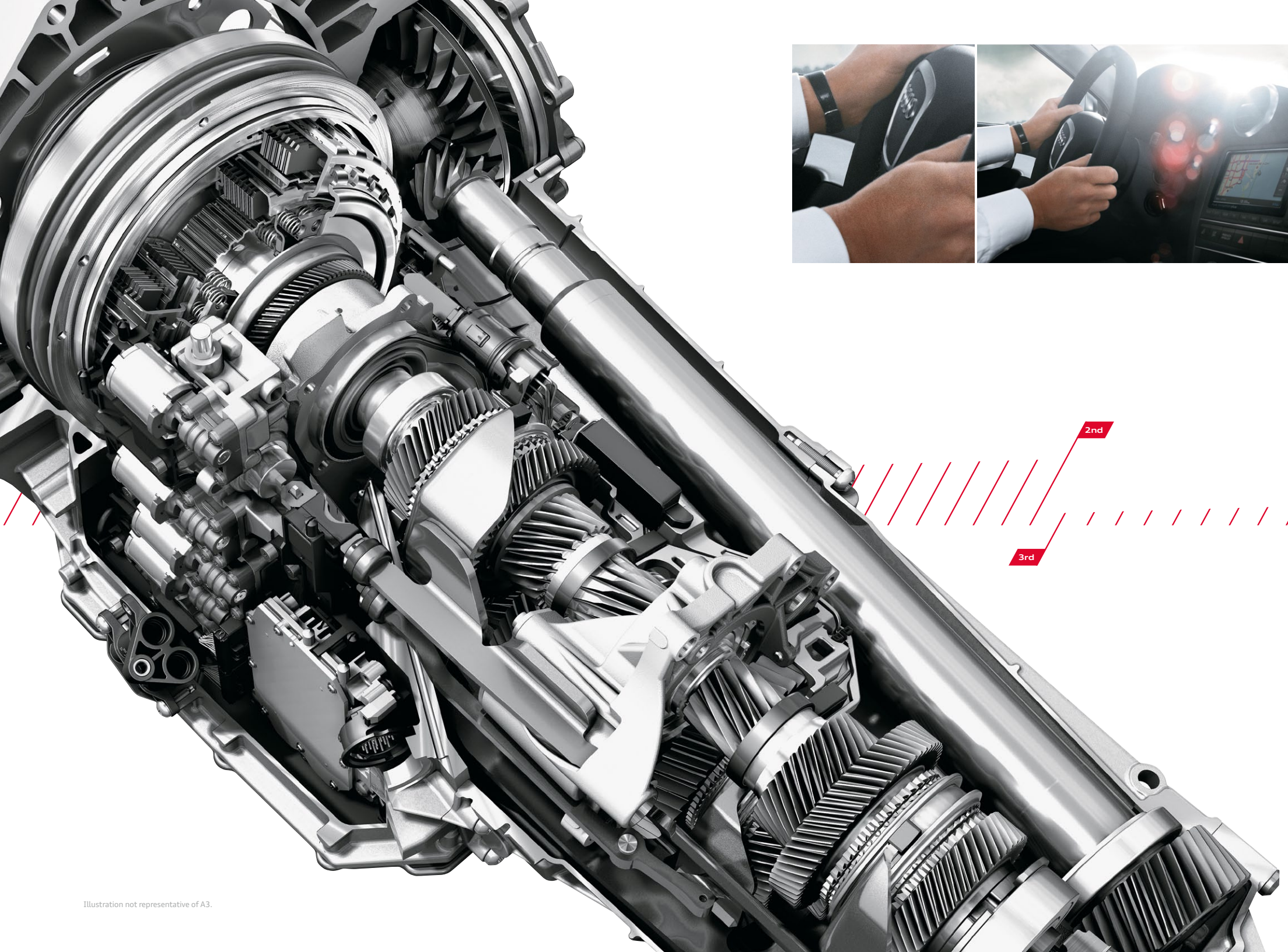
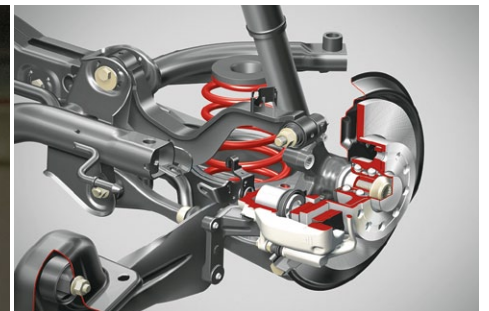
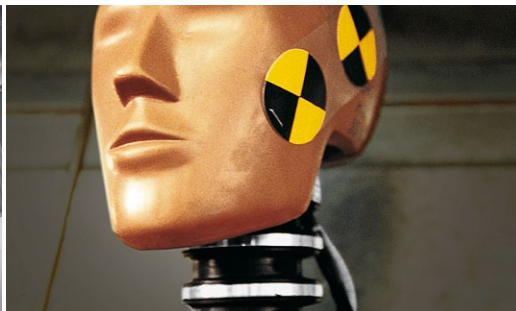

Illustration not representative of A3.

confidence

we've got your back, front, sides and top



Audi has always held firm the belief that prevention is the best safety feature of all. And the Audi A3 offers an abundance of features designed to help keep you out of harm's way. For instance, the Electronic Stabilization Program (ESP*) helps keep the vehicle traveling in its intended direction by utilizing ABS, the traction control of ASR and the electronic brake force distribution of EBD.

Audi has implemented a number of ingenious features to help maximize braking effectiveness. In wet conditions, the brake disc wiping system gently pulses the brakes to help dissipate water

buildup. Keeping the discs as dry as possible helps promote the most effective braking. Additionally, the brake assist system is able to detect an attempt at full braking and apply full stopping power when required. The advantage is that braking distance is significantly reduced.

Inside, the Audi safety systems prepare for the worst once the brake assist system is engaged. The safety belt pre-tensioners are activated, for all occupants, and lock the safety belts in place. This is intended to help keep passengers in the safest position in the event of a collision. When prevention isn't enough, the combination

of crumple zones and high-strength steel helps deliver a tremendous level of protection for the driver and passengers. Crumple zones, at the front and rear of the vehicle, are designed to help dissipate the energy and force of a collision by deforming upon impact. The high-strength steel used in and around the occupant cell is designed to protect the integrity of the passenger compartment and those within it.

The six standard, second-generation airbags* provide an additional measure of safety. They include front-impact airbags for the driver and passenger and are designed to help protect the

head. Seat-mounted, side-impact airbags for the front seat occupants are designed to help protect the thorax in a collision. And the side-curtain airbags offer front and rear occupants head protection in the event of a side collision or rollover.

Reacting to rear collision forces, the head restraints help cradle the occupant's head in an effort to reduce the likelihood of a whiplash injury.

Everything comes together to reinforce our commitment to all-encompassing safety.



We have 30 years of experience in developing the world's most sophisticated all-wheel drive system. The result is quattro®. It helps maximize traction by automatically adjusting power to each wheel, making the car feel planted – regardless of conditions. Combine ESP and race-bred braking technology, and you'll feel a level of confidence you've never experienced before.

- ▶ quattro helps increase your margin of safety by helping you maintain maximum traction in a variety of weather conditions.
- ▶ ESP helps ensure your vehicle maintains the intended direction of travel by continuously adjusting a number of drivetrain variables.
- ▶ Four-wheel disc brakes with brake disc wiping offer optimal braking in all kinds of weather.

*Airbags are supplemental restraints only and will not deploy in all crash circumstances. Always use safety belts and seat children in the rear, using restraint systems appropriate for their size and age. This is a dramatization and does not depict what will happen in an accident. All bags will not inflate in real world accidents and if multiple bags deploy they will be in various stages of inflating/deflating and will never all be inflated at the same time.

A3 Premium



A3 Premium

- ¹ **S line® exterior** | The S line® exterior accentuates the already powerful and bold exterior of the A3 with S line front and rear bumpers, rear spoiler and S line badges on the fenders.
- ² **Leather-wrapped, four-spoke steering wheel** | The leather-wrapped, four-spoke steering wheel provides a sporty look and feel, enhancing the A3 driving experience.
- ³ **Leather seating surfaces** | High-quality leather complements the vehicle seat design while enhancing the overall interior style.
- ⁴ **17" five-split-spoke wheels with 225/45 all-season tires** | The luxurious appearance of these 17" wheels is a refined complement to the A3. Additionally, year-round performance is enhanced with all-season tires, helping to ensure a safe and comfortable ride on virtually all surfaces.
- ⁵ **Audi concert radio with SIRIUS® Satellite Radio** | This stereo system integrates 140 watts of power, MP3 capability, a CD player and auxiliary input for easy access to a variety of music devices. Aside from exceptional sound quality, the system also features the Radio Data System (RDS), which displays several types of AM, FM and SIRIUS® Satellite Radio information. SIRIUS offers commercial-free music, talk and more, available with a free three-month trial subscription.
- ⁶ **Dual-zone automatic climate control** | Occupants in the driver and front passenger seats can select and control their desired level of heating or cooling via the center console. A light sensor on the dashboard adjusts the system based on the sun's intensity.
- ⁷ **Halogen headlights with daytime running lights** | Superior to conventional bulbs, halogen headlights are effective in illuminating a wide section of the road.

Features listed are standard on the Premium model unless otherwise noted.

+ FEATURE NOT SHOWN

A3 Premium Plus



A3 Premium



A3 Premium Plus

- 4 Audi xenon plus headlights with LED daytime running lights** | The signature LED daytime running lights and high-intensity headlights not only add a distinct look to the vehicle, they also help improve visibility while using half of the energy of conventional bulbs.
- 5 17" ten-spoke wheels with 225/45 all-season tires** | The motorsport-inspired 17" wheels offer a visual complement to the A3. Additionally, year-round performance is enhanced with all-season tires, helping to ensure a safe and comfortable ride on virtually all surfaces.
- 6 Leather-wrapped, three-spoke, multifunction steering wheel with shift paddles** | The leather-wrapped, three-spoke, multifunction steering wheel provides easy access to audio volume control, Bluetooth® operation, and radio and CD track selection. Shift paddles come standard on S tronic® vehicles, allowing for rapid and precise gear changes.
- 7 Aluminum Medial inlay** | The exclusive Aluminum Medial inlays in the doors and center console set the vehicle's interior apart with style and grace.
- 8 Illumination Package** | The interior Illumination Package features lighted vanity mirrors, map lights and active door reflectors. Additionally, permanent vertical ambient illumination of controls and the center console allows for readability and orientation in these areas.
- + Bluetooth® mobile phone preparation** | The advanced technology of the Audi A3 allows you to conveniently access your Bluetooth-enabled phone's features via the driver information system and Navigation System, allowing for easy, intuitive, hands-free communication. For specific compatibility and operation instructions, refer to audiusa.com/bluetooth or contact your local Audi dealer for the latest listing of compatible phones.
- + Power driver seat** | The power front seat allows the driver to electronically adjust the seat's forward/backward position, height, lumbar support and angle of seat cushion and seatback.
- + Storage Package** | The comprehensive storage system provides ample and convenient spaces for a wide variety of storage needs, including side pockets, seatback storage nets and bag hangers in the cargo area.

Features listed are standard on the Premium Plus model unless otherwise noted.

+ FEATURE NOT SHOWN



A3 Options



A3 Options

A3 Packages

¹ **Open Sky panorama sunroof** | The easy-to-operate Open Sky system includes a two-piece glass sunroof, offering the driver and passengers natural light, an unobstructed view overhead and a continuous flow of fresh air within the cabin.

² **Dark Brown Walnut wood inlay** | Located on the center console and door panels, the genuine Dark Brown Walnut wood inlay adds a refined touch to the luxurious interior.

³ **Audi Navigation plus** | The DVD-based Audi Navigation plus features a full-color 6.25" LCD screen and MMI[®]-inspired control logic for media, SIRIUS[®] Satellite Radio, navigation and telephone functions. The system also includes two SD card slots for your MP3 music and the option of a six-CD changer or iPod[®] interface.
[Premium Plus only]

⁴ **Rear side airbags*** | The A3 offers rear side airbags, which can help reduce injuries in certain collisions.

⁵ **Aluminum roofrails** | The multifunctional, low-profile aluminum roofrails complement the vehicle's progressive design while adding an extra element of versatility. When paired with the optional Titanium Sport Package, rails come in black.

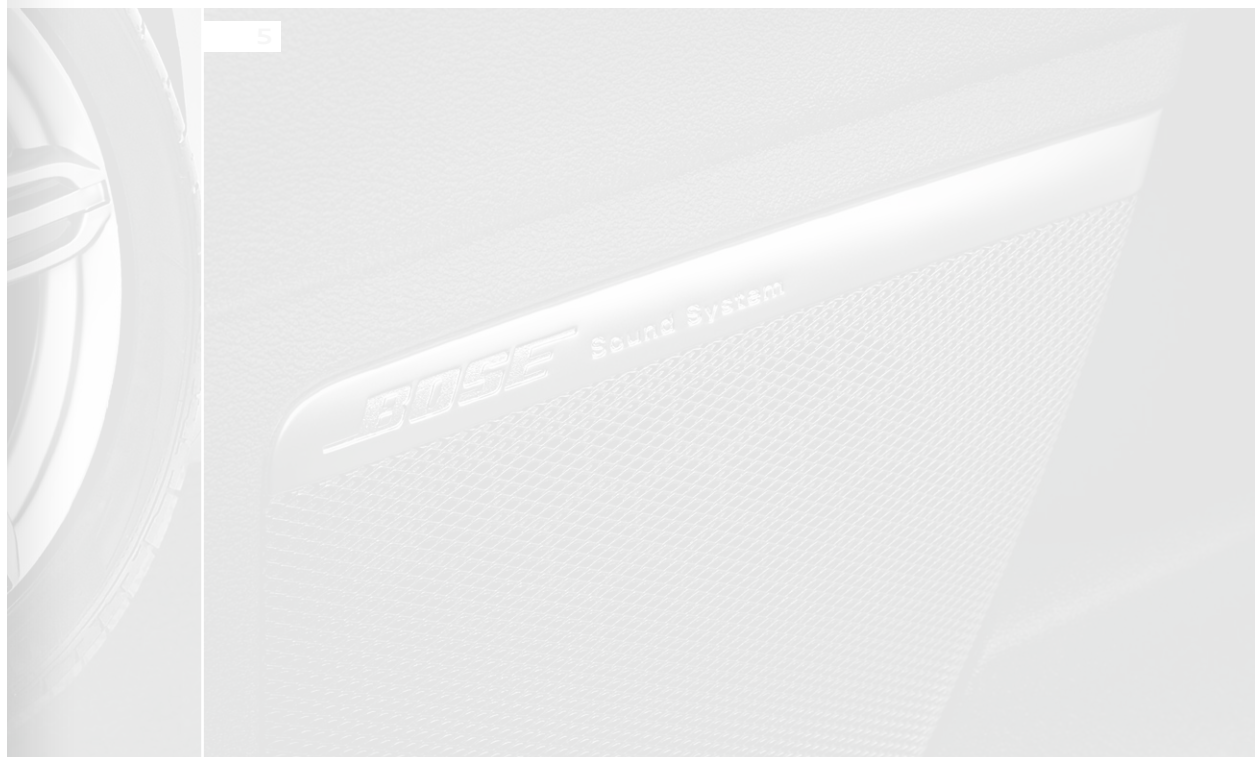

*Airbags are supplemental restraints only and will not deploy in all crash circumstances. Always use safety belts and seat children in the rear, using restraint systems appropriate for their size and age.

+ FEATURE NOT SHOWN



A3 Packages

- 4 Sport Package** | For more performance-oriented handling characteristics, the Sport Package includes a lower, firmer suspension and sport seats that offer greater lateral support. The 18" five-tri-spoke wheels have a bold, aggressive design and come equipped with 225/40 summer performance tires.
- 5 Convenience Package** | The Convenience Package includes many features to make your ride more enjoyable. Individually tailored to the A3 interior, the BOSE® premium sound system is further enhanced by the AudioPilot® noise compensation system and transforms the A3 into your personal concert hall on wheels. Also included is the auto-dimming interior mirror with compass, which recognizes distracting bright light behind the car and darkens the mirror glass automatically. The rain/light sensor detects the level of light and automatically turns on the headlights if needed, while offering the same convenience in wet conditions by automatically adjusting the rate of wiper sweep to the amount of rain. Also includes rear ultrasonic parking sensors, which measure the distance to the nearest object and audibly warn you when the distance becomes unsafe. [Premium Plus only]
- 6 Cold Weather Package** | This package provides the driver and front passenger their ideal level of comfort via the multilevel seat heating system, which is designed to heat the entire surface of the seat; warming is initiated with a convenient knob. Also included are heated exterior mirrors, which house integrated LED turn signals and are heated to prevent fogging. Heated windshield washer nozzles are also included, which prevent the nozzles from freezing and allow you to wash the windshield in cold temperatures.
- 7 Titanium Sport Package** | Inspired by the Audi motorsport legacy, the Titanium Sport Package includes a number of aesthetic and performance enhancements. Exterior elements include 18" Dark Titanium-finish wheels and the iconic Singleframe® grille flanked by Gloss Black elements. Inside, the aggressive look is continued throughout with an exclusive black headliner, Piano Black inlays and S line® sport seats with perforated Alcantara® inserts and S line doorsills. Enhanced handling performance comes from a specially tuned, lowered sport suspension that gives your Audi a low, assertive stance. Optional roofrails are black with this package. [Premium Plus only]
- 8 Bluetooth® Comfort Package** | Adding to the already versatile nature of your A3, the Bluetooth® Comfort Package includes Bluetooth mobile phone preparation, allowing easy, intuitive hands-free communication with your Bluetooth-enabled phone's features via the multifunctional steering wheel. The included power driver seat with lumbar support allows the driver to electronically adjust the seat's forward/backward position, height, lumbar support and angle of seat cushion and seatback. [Premium only]

* See page 38 for important safety information regarding summer performance tires.



A3 Accessories

1



2



3



4



5



A3 Accessories

¹ **Compact roof box** | A trim, aerodynamic design that offers a generous 16.95 cu. ft. capacity. The perfect size and design for your A3. Size: 81" long, 30" wide. [Must be used in combination with the base carrier bars, which are sold separately]

² **Premium all-weather floor mats** | These rubber floor mats feature a deep ribbed channel design to help protect the floor and carpeting from water, mud, sand and snow. Rubber mats come with contrasting logo. Set of four floor mats.

³ **Audi 18" Calera wheels** | These alloy wheels grab attention with their distinctive dual-spoke design. All of our alloy wheels are specially engineered to meet the strict tolerances of our Audi original equipment wheels.

⁴ **18" Castell alloy wheel** | Nothing enhances the look of your A3 faster than a set of new alloy wheels. Not only are they striking in appearance, they must also submit to rigorous quality assessments, including corrosion testing. See your authorized Audi Dealer for details.

⁵ **Barracuda® bicycle holder** | This locking holder fits 20-80 mm bike frames with both wheels on the bike and keeps the bike upright as you secure it in place. Two racks shown. [Must be used in combination with the base carrier bars, which are sold separately; two bike holders shown. Bicycle not included.]

⁶ **Storage cover** | Protect your Audi from the elements with a lightweight, easy-to-use cover. Stormshield® material is custom designed to help protect your Audi A3 from the elements. Includes a storage bag.

⁷ **Carpeted cargo mat** | This heavy-duty, moisture-resistant rubber mat is covered by a nylon carpet to help provide excellent trunk protection. Movable plastic blocks attach with hook and loop to the carpet to help organize and manage the movement of items in the trunk.

A3 Wheels

3



4



A3 Accessories

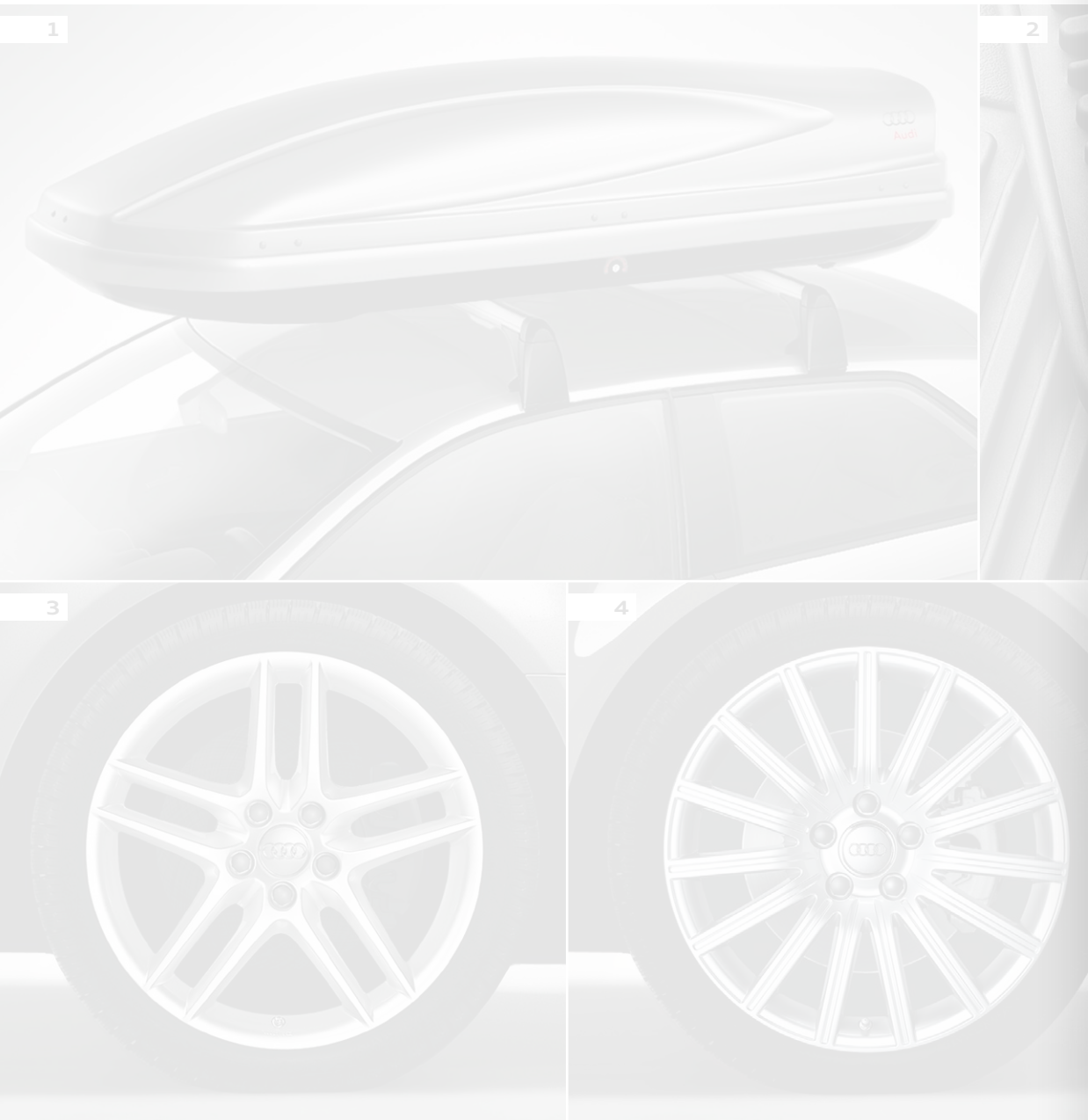

A3 Wheels

- 17" five-split-spoke wheels with 225/45 all-season tires** | The luxurious appearance of these 17" wheels is a refined complement to the A3. Additionally, year-round performance is enhanced with all-season tires, helping to ensure a safe and comfortable ride on virtually all surfaces. [A3 Premium]
- 17" ten-spoke wheels with 225/45 all-season tires** | The motorsport-inspired 17" wheels offer a visual complement to the A3. Additionally, year-round performance is enhanced with all-season tires, helping to ensure a safe and comfortable ride on virtually all surfaces. [A3 Premium Plus]
- 18" five-tri-spoke wheels with 225/40 summer performance tires*** | The aggressively styled 18" sport-oriented wheels are equipped with summer performance tires, which help to improve handling and driving dynamics. [Sport Package only]
- Titanium Sport Package wheels with 225/40 summer performance tires*** | The 18" Dark Titanium-finish wheels are reminiscent of the race track while the summer performance tires help to improve handling and driving dynamics. [Titanium Sport Package only]

* Summer performance tires are designed for optimum performance and handling in warm climates. They are not suitable for cold, snowy or icy weather conditions. If you drive under those circumstances, you should equip your vehicle with all-season or winter tires, which offer better traction under those conditions. We suggest you use the recommended winter or all-season tires specified for your car or their equivalent. These summer performance tires also have a lower aspect ratio that aids performance and handling. However, in order to avoid tire, rim or vehicle damage, it is important that the inflation pressure is regularly checked and maintained at recommended levels. Serious wheel and tire damage may occur if the vehicle is operated on rough or damaged road surfaces, or upon encountering road debris or obstacles. Please also remember in making your selection that, while these tires deliver responsive handling, they may ride less comfortably and make more noise than other choices. Finally, these tires may wear more quickly than other choices. For more information on all of these topics, please consult the owner's manual, your local dealer or call 1-800-FOR-AUDI.

A3 Wheels

1



3



2



4



A3 Interior Seating | Decorative Inlay

BLACK LEATHER | FLEXMETALLIC INLAY



DECORATIVE INLAY OPTIONS

- FLEXMETALLIC INLAY**
(Standard)
- DARK BROWN WALNUT WOOD INLAY**
(Option)
- ALUMINUM MEDIAL INLAY**
(Option)
- PIANO BLACK INLAY**
(Titanium Sport Package only)

LUXOR BEIGE LEATHER | DARK BROWN WALNUT WOOD INLAY*



* Optional inlay shown

LIGHT GRAY LEATHER | ALUMINUM MEDIAL INLAY*



BLACK LEATHER/PERFORATED ALCANTARA* | PIANO BLACK INLAY* [Titanium Sport Package only]



A3 Make yours.



A3 Brilliant Black

-
- 1 | Black*
 - 2 | Luxor Beige
 - 3 | Light Gray
-

* Available in standard leather or leather/perforated Alcantara* with Titanium Sport Package
† Additional charge





A3 Scuba Blue METALLIC*



A3 Meteor Gray PEARL EFFECT*



A3 Ice Silver METALLIC*



A3 Deep Sea Blue PEARL EFFECT*

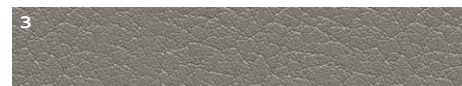
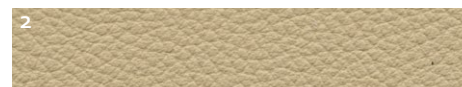
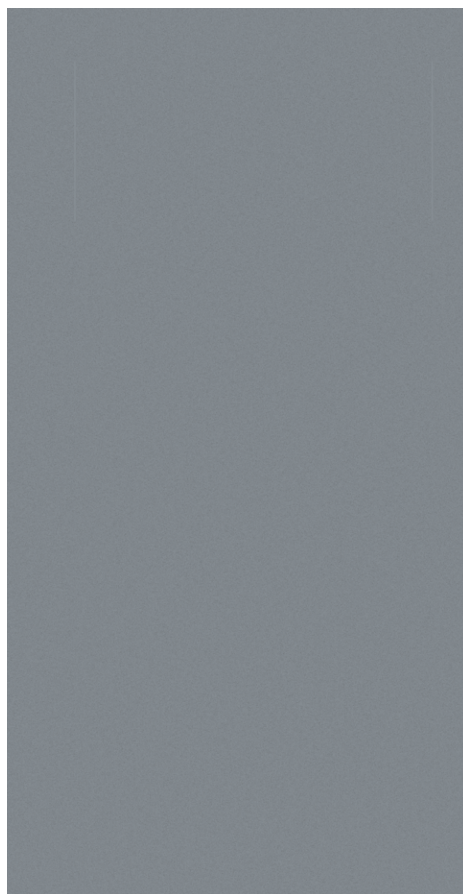
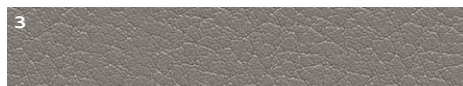
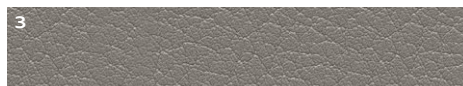
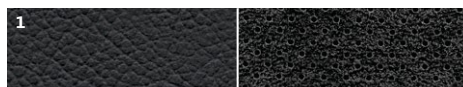
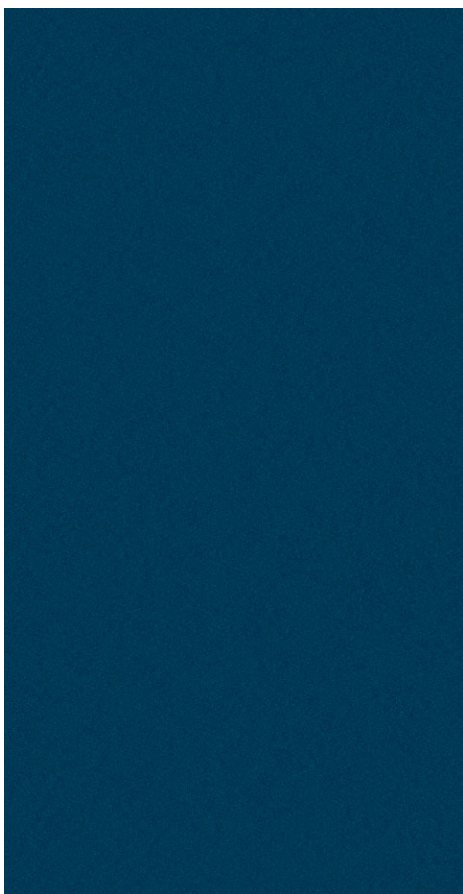
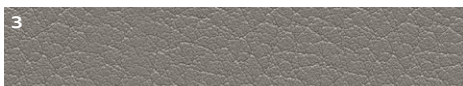



A3 Lava Gray PEARL EFFECT*



A3 Brilliant Red



A3 Ibis White



A3 Monza Silver METALLIC*

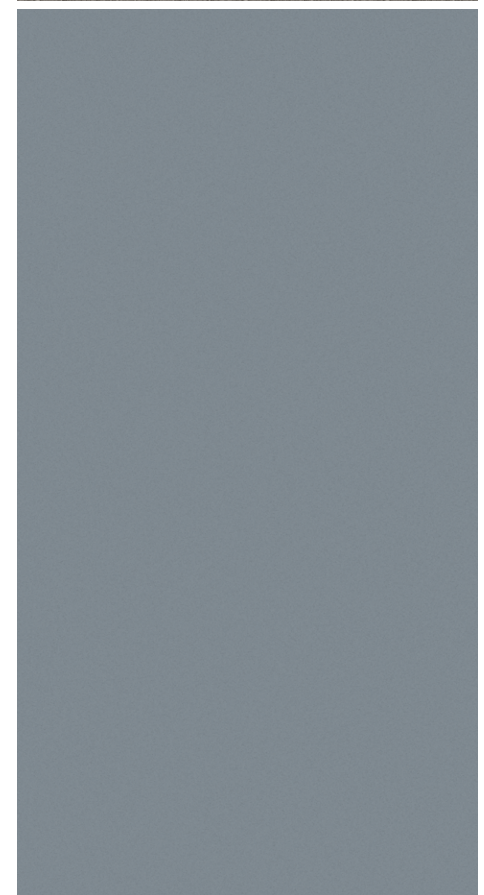
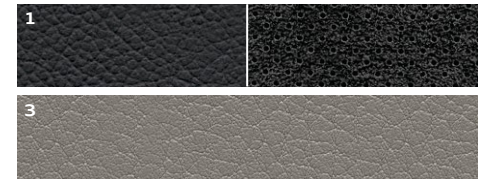
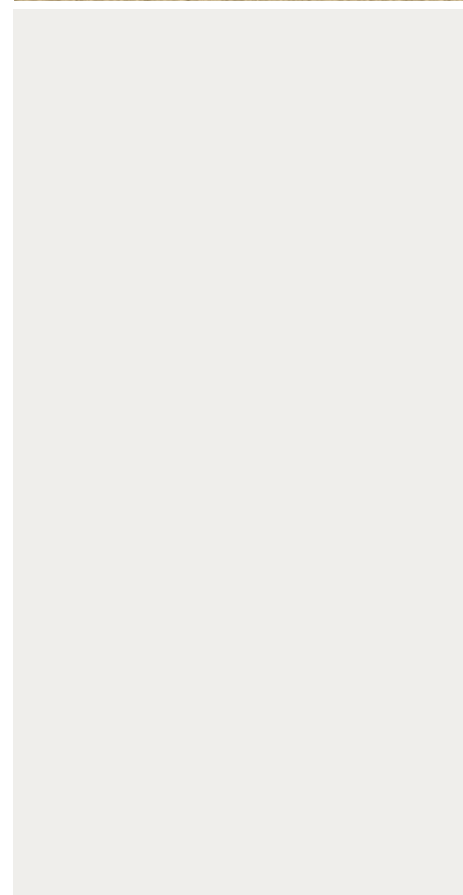
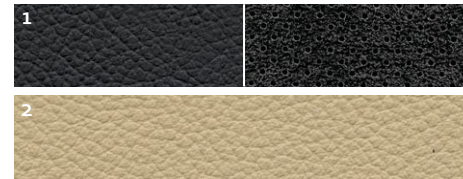
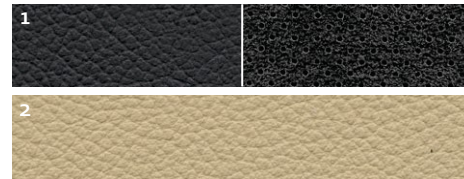
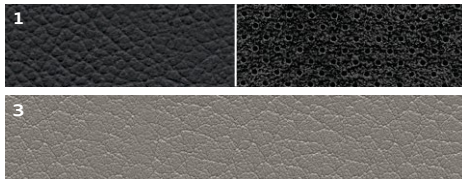

A3 Specifications | Configurations

Chassis | Technical

A3

MacPherson front suspension with direct anti-roll bar mountings, individually installed springs and shock absorber pivots, and five-piece aluminum subframe	S
Four-link rear suspension with individual springs/shock absorbers and a tubular anti-roll bar	S
Servotronic® speed-sensitive power steering - varies assistance based on vehicle speed	S
quattro® permanent all-wheel drive system utilizing Haldex center differential [Not available on A3 TDI*]	0
Six-speed manual transmission [Not available on A3 TDI]	S
Six-speed S tronic® dual-clutch automatic transmission	0
Fully galvanized steel unibody with multistep anti-corrosion protection	S

Safety | Security

A3

Driver and front passenger advanced dual-stage airbag* supplemental restraints	S
Driver and front passenger seat-mounted side thorax airbag* supplemental restraints	S
Second row side airbag* supplemental restraint system	0
Sideguard® head curtain airbags* for both rows of seats	S
Front passenger occupant detection for airbag* supplemental restraints	S
Front three-point safety belts for with automatic pre-tensioning and force limiters; height adjustable for front seating positions	S
Rear three-point safety belts with belt force limiters for outboard passenger seating positions	S
Safety belt reminder for driver and front passenger	S
Lower Anchors and Tethers for CHildren (LATCH) in rear seats	S
Pinch protection for passenger compartment windows	S
Central locking system with selective unlock feature	S
Impact protection – including reinforced high-strength steel/aluminum cross members, reinforced bumpers and rigid occupant cell	S
Tire pressure monitoring system	S
Electronic Stabilization Program (ESP®)	S
Anti-lock Brake System (ABS) with Electronic Brake-pressure Distribution (EBD)	S
Brake assist – a system that automatically senses emergency braking and applies maximum power boost to reduce overall stopping distance	S
Audi hill hold assist	S
Anti-theft vehicle alarm system with blinking theft-deterrent light	S

0	Option	S	Standard
---	--------	---	----------

The table above represents the standard equipment on the Premium model. Many popular options are combined and available on the Premium Plus and Prestige models. Please see the package contents in this brochure for complete details.

Exterior	A3
Singleframe® grille with choice of front license plate holder or filler panel with two chrome strips	S
LED turn signals in mirror housings	S
Aluminum roofrails	O
Black roofrails [Titanium Sport Package only]	O
Single exhaust pipe, positioned left [TDI* only]	S
Dual exhaust pipes, positioned left	S
Halogen headlights with integrated high and low beams	S
Audi xenon plus headlights with LED daytime running lights	O
Two front foglights located in lower front bumper	S
Taillights with LED light pipe technology	S
Power-adjustable side mirrors	S
Open Sky panorama sunroof with retractable sunshade	O
S line® front and rear bumpers	S
S line rear spoiler	S

Interior	A3
Leather-wrapped, four-spoke, multifunction steering wheel with controls for audio volume, Bluetooth® phone and audio seek function	S
Leather-wrapped, three-spoke, multifunction sport steering wheel with shift paddles and controls for audio volume, Bluetooth® phone and audio seek function	O
Tilt and telescopic manually adjustable steering column	S
Interior lights in overhead console	S
Red ambient LED lighting in headliner for front center console illumination	O
Front map lights with illumination for interior door handles, air vent controls and front footwells	O
Front and rear floor mats	S
Flexmetallic decorative inlays	S
Aluminum Medial decorative inlays	O
Genuine wood decorative inlays [Dark Brown Walnut]	O
Aluminum doorsill inlays	S
Folding front center armrest	S
Storage nets in the back of front seats	O
Power central locking system with radio-operated key fob, remote control for doors, deck lid and fuel door	S
Dual-zone automatic climate control	S

Interior <small>(CONTINUED)</small>	A3
Power windows with one-touch up/down operation and pinch protection	S
Electric rear window defogger with automatic timed shut off feature	S
Interior tailgate release on driver's door	S
Dual front sun visors with vanity mirror for driver and front passenger	S
Lighted vanity mirrors for driver and front passenger	O
Four assist handles in headliners above each door with slow retraction feature	S
Leather seating surfaces	S
Six-way manual driver seat	S
Eight-way power driver seat with four-way power lumbar adjustment	O
Six-way manual front passenger seat	S
Sport front seats	O
Split folding 60/40 rear seatbacks	S
Rear seat armrest with dual cup holders	S
Two front cup holders	S

Infotainment Technology	A3
Audi concert system with single CD player with MP3 playback capability, AM/FM radio, auxiliary input jack and speed-dependent volume control	S
SIRIUS® Satellite Radio with three-month trial subscription	S
Audi Sound System, 140 watts with ten speakers, subwoofer and center fill speaker	S
BOSE® premium sound system	O
Bluetooth® preparation for mobile phones	O
Backlit instrument cluster with brightness control	S
Audi Navigation plus¹ with six-CD changer or Audi music interface, AM/FM radio, two SD card slots for MP3 files, auxiliary input jack and SIRIUS Satellite Radio	O
Digital trip odometer with service interval indicator	S
Driver information system – trip computer, outside temperature, radio/telephone/navigation display, Auto-Check, open door/hatch indicator	S
Electronic cruise control	S
Rain sensor for automatic windshield wipers	O
Automatic headlight switch	O

* Airbags are supplemental restraints only and will not deploy under all crash circumstances. Always use safety belts and seat children in the rear, using restraint systems appropriate for their size and age.

† Your Audi vehicle is equipped with a phone preparation utilizing Bluetooth interface to enable hands-free functionality [compatible mobile phones sold separately]. You will need a Bluetooth-enabled mobile phone in order to utilize this function. Not all Bluetooth-enabled mobile phone models are compatible with Audi phone preparation. Visit audiusa.com/bluetooth, or contact your local Audi dealer for the latest listing of compatible phones. Audi recommends use of the Audi phone cradle [sold separately] with your mobile phone while operating this vehicle.

‡ Audi Navigation plus depends on signals from the worldwide Global Positioning Satellite network. The vehicle's electrical system, and existing wireless and satellite technologies, must be available and operating properly for the system to function. The system is designed to provide you with suggested routes in locating addresses, destination and other points of interest. Changes in street names, construction zones, traffic flow, points of interest and other road system changes are beyond the control of Audi of America, Inc. Complete detailed mapping of lanes, roads, streets, toll roads, highways, etc., is not possible, therefore you may encounter discrepancies between the mapping and your actual location. Please rely on your individual judgement in determining whether or not to follow a suggested Audi Navigation plus route. Periodically, the mapping is updated, and a new DVD will be required in order to maintain the latest navigation information available to us. These will be available for purchase from time to time at an additional cost. Consult your dealer or call 1-800-FOR-AUDI for details.

A3 Model Configurations

- 2.0 TFSI® six-speed manual transmission and front-wheel drive
- 2.0 TFSI six-speed S tronic® automatic transmission and front-wheel drive
- 2.0 TFSI six-speed S tronic automatic transmission and quattro® all-wheel drive

Power and Performance

- + 2.0 liter turbocharged, DOHC in-line four-cylinder engine with FSI® direct injection, intercooler and four valves per cylinder
- + Horsepower: 200hp @ 5100-6000 RPM
- + Torque: 207 lb-ft. @ 1800-5000 RPM
- + 0-60 MPH in seconds – Manual: 7.1, S tronic: 6.9, S tronic quattro: 6.7
- + Top track speed*: 130 MPH
- + Fuel economy estimates, city/highway*: Manual: 21/30 MPG, S tronic: 22/28 MPG, S tronic quattro: 21/28 MPG

- 2.0 TDI® clean diesel six-speed S tronic automatic transmission and front-wheel drive

Power and Performance

- + 2.0 liter turbocharged, DOHC in-line four-cylinder engine with TDI clean diesel common-rail direct injection, intercooler and four valves per cylinder
- + Horsepower: 140hp @ 4200 RPM
- + Torque: 236 lb-ft. @ 1750-2500 RPM
- + 0-60 MPH in seconds: 8.9
- + Top track speed*: 130 MPH
- + Fuel economy estimates, city/highway*: 30/42 MPG

A3 Dimensions

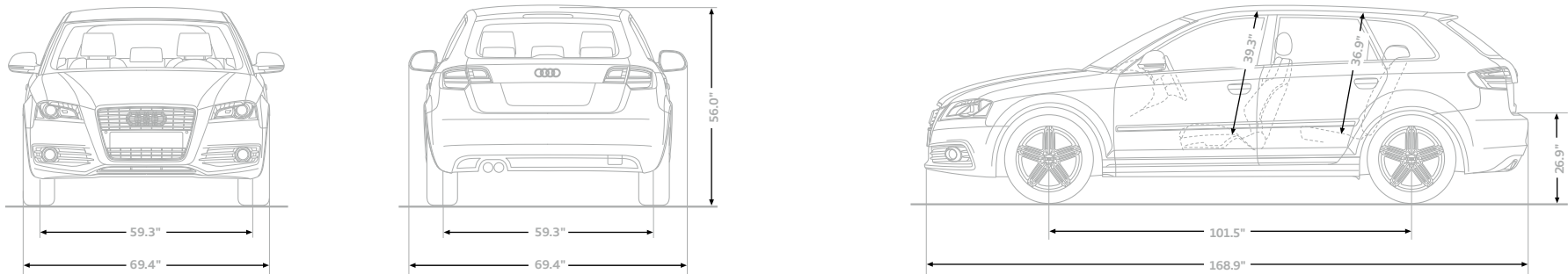

* Top track speed for A3 electronically limited to 130 MPH in the U.S. Obey all local speed and traffic laws. † EPA fuel economy estimates. Your mileage will vary.

2011 | A3

Audi of America

Audiusa.com

[Facebook.com/Audi](https://www.facebook.com/Audi)

BR-A3-10-1200US

Note: A word about this brochure. Audi of America, Inc. believes the specifications in this brochure to be correct at the time of printing. However, specifications, standard equipment, options, and colors are subject to change without notice. Some equipment may be unavailable when your vehicle is built. Please ask your dealer for advice concerning current availability of standard and optional equipment, and your dealer will verify that your vehicle will include the equipment you ordered. Vehicles in this brochure are shown with optional equipment. See your dealer for complete details on the new-vehicle limited warranty, twelve-year limited warranty against corrosion perforation, and Audi 24/7 Roadside Assistance. [Roadside assistance coverage provided by Road America in the U.S. Certain conditions apply; see your dealer for details.] Tires supplied by various manufacturers. "Truth in Engineering" is a registered trademark of Audi of America, Inc. "Audi," "quattro," all model names, "MMI," "FSI," "TFSI," "S tronic," "Sideguard," "Singleframe," the Singleframe grille design, and the four rings logo are registered trademarks of AUDI AG. "Servotronic" is a registered trademark of the AM General Corporation. "Bose" and "AudioPilot" are registered trademarks of the Bose Corporation. "Alcantara" is a registered trademark of Alcantara S.P.A. "ESP" is a registered trademark of Daimler AG. "TDI" is a registered trademark of Volkswagen AG. "SIRIUS" is a registered trademark of SIRIUS Satellite Radio, Inc. "Bluetooth" is a registered trademark of Bluetooth SIG. "iPod" is a registered trademark of Apple Computer, Inc.

©2010 Audi of America, Inc.